

LMD-2110MD

21.5-inch Full HD 2D LCD medical monitor



Overview

Full HD resolution monitor complies with medical safety standards

The LMD-2110MD monitor features a 21.5-inch LCD panel of full HD (1920 x 1080) resolution and 10-bit signal processing. Complying with medical safety standards and EMC standards, the monitor provides a crisp, sharp high definition image.

Input versatility

The LMD-2110MD is equipped with an analogue video input and output terminals as standard. It also features an HDMI input, which accepts HD signals up to 1080/60P. In addition, the monitor can input HD/SD-SDI signals using an optional input adaptor.

Features

Cost-effective feature-rich performance

The LMD-2110MD offers professional functionality in an economic package. Optimised for moving picture reproduction, it delivers accurate colour rendition and greyscale - thanks to its CRT-like gamma curve and 10-bit signal processing.

Full HD-resolution LCD panel

The LMD-2110MD delivers outstandingly crisp, high brightness and high contrast widescreen HD images with a fast transient response.

Wide range of standard input interfaces

The LMD-2110MD is equipped with a full range of analogue SD inputs, including composite NTSC/PAL, Y/C (S-Video), 525i/625i component, and RGB. Also included is an HDMI input, which can accept HD digital signals up to 1080/50p and 60p. DVI signals can be input via the HDMI input connector using a conversion cable.

Optional HD-SDI interface

The LMD-2110MD supports HD-SDI input with an optional BKM-341HS HD/SD-SDI input adaptor. This input versatility allows the LMD-2110MD monitor to flexibly connect to HD-SDI digital environments. The monitor can also handle SD-SDI input using an optional BKM-320D SD-SDI input adaptor.

Compliance with medical standards

This product is distributed to the US and EU as a medical device and satisfies product safety standards (e.g. IEC 60601-1). For more details, please contact your nearest Sony sales office or an authorized dealer.

Remote control

The monitor allows external remote control via a programmable parallel remote interface.

VESA mounting

The monitor can stand on a desktop or be mounted on the wall or ceiling with a 100 x 100mm VESA arm mount.

Specifications

Picture Performance	
Type	a-Si TFT Active Matrix LCD
Resolution	1920 x 1080 pixels (Full HD)
Effective picture size (H x W) (Diagonal)	477 x 268 mm (18 7/8 x 10 5/8 inches), 547 mm (21 5/8 inches)
Aspect	16:9
Colors	Approx. 16.7 million colors
Viewing angle (LCD panel specification)	170°/160° (typical) (horizontal/vertical contrast >10:1)
Input	
Composite	BNC (x1), 1.0 Vp-p ±3 dB sync negative
Y/C	Mini DIN 4-pin (x1) Y: 1.0 Vp-p ±3 dB sync negative, C: 0.286 Vp-p ±3 dB (NTSC burst signal level), 0.3 Vp-p ±3 dB (PAL burst signal level)
RGB, Component	BNC (x3) RGB: 0.7 Vp-p ±3 dB (Sync On Green, 0.3 Vp-p sync negative) Component: 0.7 Vp-p ±3 dB (75% chrominance standard color bar signal)
HDMI	HDMI (x1)
Audio	Phono jack (x2), -5 dBu 47 kilohms or higher OPTIONAL AUDIO IN: Phono jack (x1), -5 dBu 47 kilohms or higher
External sync	BNC (x1) 0.3 Vp-p to 4.0 Vp-p ±bipolarity ternary or negative polarity binary
Option in connector	D-sub 9-pin (x1), female
Parallel remote	Modular connector 8-pin (x1) (pin-assignable)
Output	
Composite	BNC (x1), loop-through, with 75 ohms automatic termination
Y/C	Mini DIN 4-pin (x1), loop-through, with 75 ohms automatic termination

RGB, Component	BNC (x3), loop-through, with 75 ohms automatic termination
External sync	BNC (x1), loop-through, with 75 ohms automatic termination
Audio monitor out	Phono jack (x2), loop-through
Speaker (built-in)	0.5 W (mono)

General

Power requirements	AC 100 V to 240 V, 50/60 Hz
Power consumption	Maximum: approx. 60 W, 1.0 A to 0.5 A
Operating temperature	0°C to 35°C (32°F to 95°F) Recommended: 20°C to 30°C (68°F to 86°F)
Operating humidity	30% to 85% (no condensation)
Storage and transport temperature	-20°C to +60°C (-4°F to +140°F)
Storage and transport humidity	0% to 90%
Operating, storage and transport pressure	700 hPa to 1060 hPa
Dimensions (W x H x D) (with stand)	515 x 403 x 264 mm (20 3/8 x 15 7/8 x 10 1/2 inches)
Dimensions (W x H x D) (without stand)	515 x 355 x 86 mm (20 3/8 x 14 x 3 1/2 inches)
Mass	8.6 kg (18 lb 15 oz)
Mass (without stand)	6.9 kg (14 lb 19 oz)

Supplied Accessories

AC power cord (1)
AC plug holder (2)
Before Using This Unit (1)
CD-ROM (including the Instructions for Use) (1)
Service Contact List (1)

Related products



BKM-341HS

HD / SD-SDI input adaptor

Gallery





2016 LG Medical Imaging Displays

8MP Clinical Review Monitor (27HJ712C) | 8MP Surgical Monitor (27HJ710S)

8MP CLINICAL REVIEW MONITOR

A Display compliant with DICOM Part 14 for Clinical Review Applications

Easily multi-task while clinical reviewing from different clinical review applications such as department of radiology and exchanges and study information!

27HJ712C

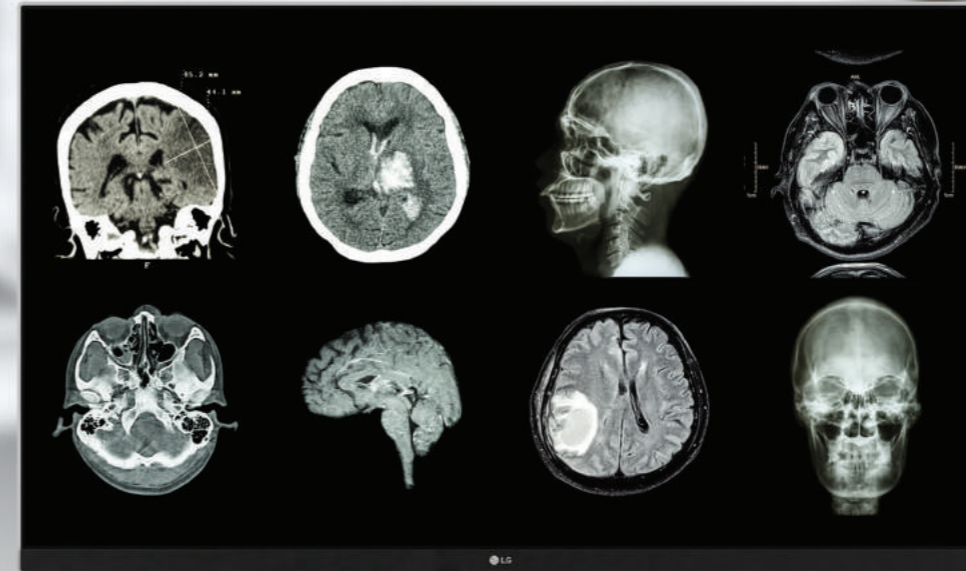

8MP IPS Display & 350 nits with sRGB over 99%

The 27-inch 8MP display with IPS technology offers an outstanding picture quality along with perfect wide viewing angles. With its 178 wide viewing angles, images can be viewed simultaneously by several people with the highest quality reproduction and minimal color shift. Furthermore, a wide range of colors represented by sRGB over 99% of the color space guarantee vivid color expression without any color shift for more precise clinical review.

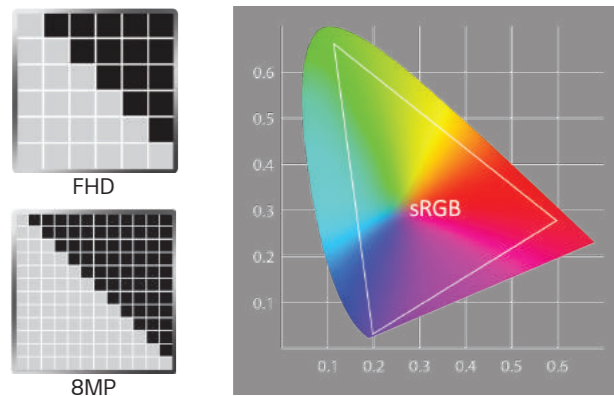

*8MP(Mega Pixel): 4K, 3840x2160

DICOM Part 14

In the medical field, monitors must display images accurately and consistently especially for the grayscale tone that may vary even between two monitors of the same model. To ensure the most accurate and consistent shading possible for medical images, LG measures and sets every grayscale tone on the production line to produce a monitor compliant with DICOM Part 14.

DICOM Part 14, published by the National Electrical Manufacturers Association (NEMA) and the American College of Radiology (ACR), provides strict guidelines for how grayscale display function calibration and quality assurance tests should be performed on displays used in medical imaging applications.



*DICOM (Digital Imaging and Communications in Medicine): Standard applied to the grayscale tone characteristics of monitors used in the medical field.

Dynamic Sync Mode

Whenever a scanning is done after checking up, a lot of heavy information is created which is hard to get all information at once clearly.

Since the LG clinical review monitor supports low input lag and quick response time, it allows the monitor to receive a signal quickly and display a clear image with no distortion for precise decoding of information for efficient clinical review.

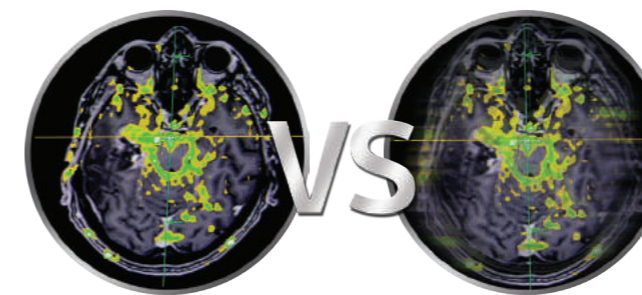

Low Input Lag & Quick Response Time

*Dynamic Sync Mode is only available to 60Hz input source.

Brightness Stabilization

A sensor measured the backlight brightness stability and automatically compensates for brightness fluctuations caused by aging for a consistently stable display during the usage time.

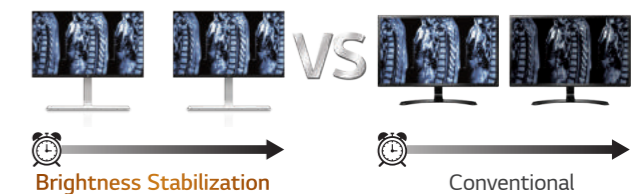

Eye-comfort features

Flicker-Safe protects eyes from fatigue by virtually eliminating flickering. The steady image helps doctors protect their vision and allows them to continue working as long as they want.

Also, **Reader Mode** provides optimal conditions for clinical use. LG's Reader Mode technology reduces blue light, protecting doctors' eyes from fatigue.

8MP SURGICAL MONITOR

A Display Optimized for Operating Room

The superior detailed picture quality of the LG surgical monitor meets operating room requirements. With its 27-inch IPS 8MP display, the LG surgical monitor improves work efficiency not only by enabling detailed observation but also by displaying multiple imaging applications.

27HJ710S

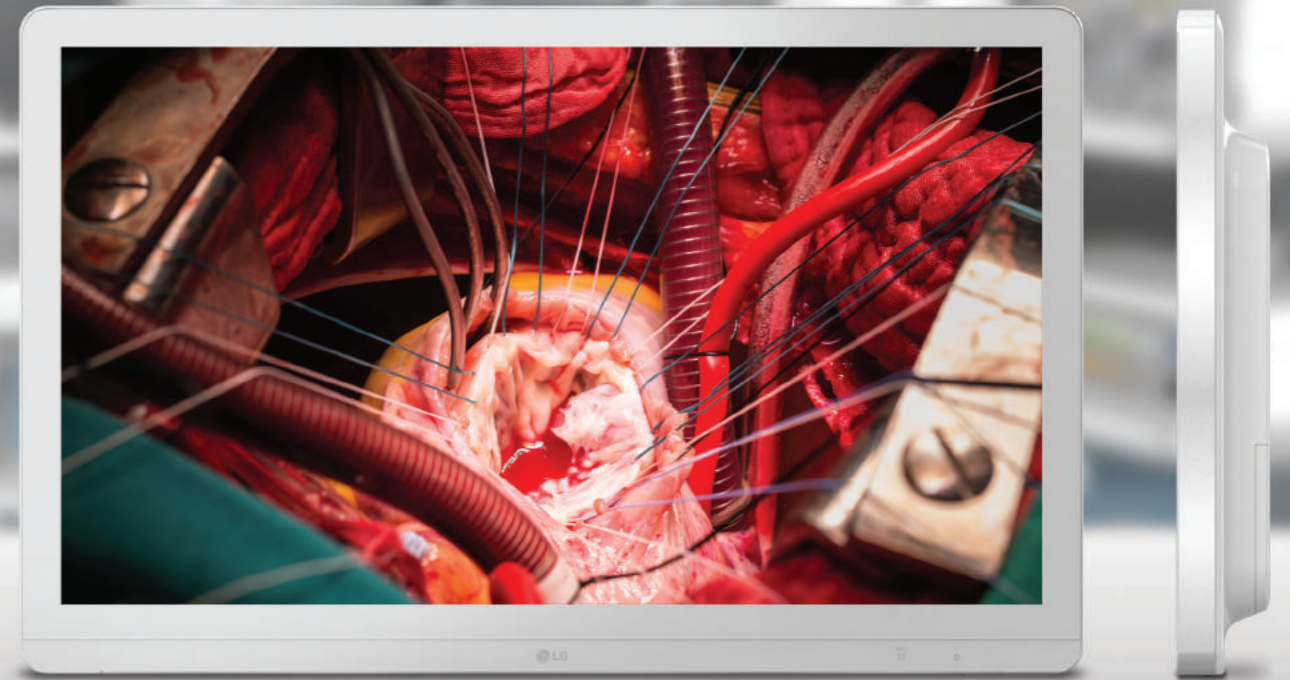

IPS & sRGB over 99% + Deep RED

The 8MP IPS display not only enables detailed observation of previously hard-to-see regions but also displays multiple imaging applications. In particular, the LG surgical monitor provides brightness and sRGB over 99% to ensure accurate color reproduction in surgery room. Moreover, by adding deep red color spectrum, LG surgical monitor assures color expression of red spectrum.

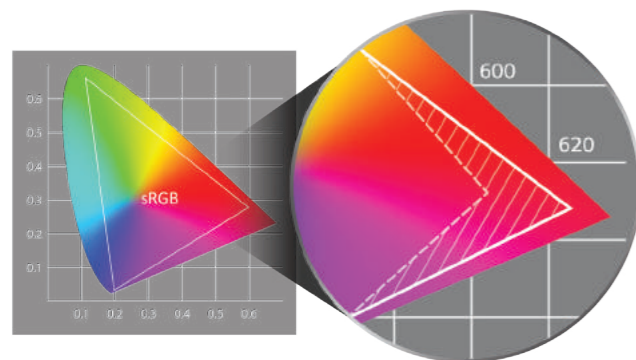

*8MP(Mega Pixel): 4K, 3840x2160

DICOM Part 14 & Brightness Stabilization

With various features to stabilize and adjust the brightness to meet standard viewing requirements, the LG surgical monitor carefully measures and sets every grayscale tone to create a monitor compliant with DICOM Part 14 to ensure visual accuracy and consistency. Furthermore, LG's surgical monitors offer stabilized brightness settings that quickly adapt during the surgical procedure to correspond to local lighting conditions.

DICOM Part 14, published by the National Electrical Manufacturers Association (NEMA) and the American College of Radiology (ACR), provides strict guidelines for performing grayscale display function calibration and quality assurance tests on displays used in medical imaging applications.

*DICOM (Digital Imaging and Communications in Medicine): Standard applied to the grayscale tone characteristics of monitors used in the medical field.

Dynamic Sync Mode

Since during an operation, a display takes a lot of heavy information from many other devices those tracking the real-time condition of the patient, therefore visual distracting caused. The LG surgical monitor can catch every single moment in real-time by supporting low input lag while synchronizing your senses with real-time scenes happening in a fast-paced information. Not only that, since the LG surgical monitor supports quick response time, it displays real-time information clearly without blurring from moving objects.

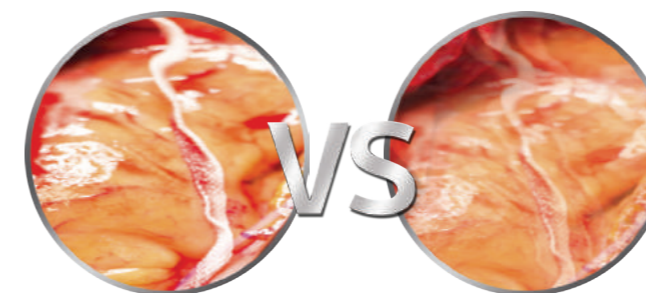

Low Input Lag & Quick Response Time vs Conventional

*Dynamic Sync Mode is only available to 60Hz input source.

Dustproof & Waterproof

The LG's multi-coated glass is highly durable and scratch-resistant and protects the panel during a surgical procedure. The front panel of the LG surgical monitor has an IP35 protection level and the back panel has an IP32 level, securing it against any water or fluids that may contact it during an operation. In addition to the waterproofing safeguards, its flat surface allows for easy cleaning of the 8MP panel and control buttons.

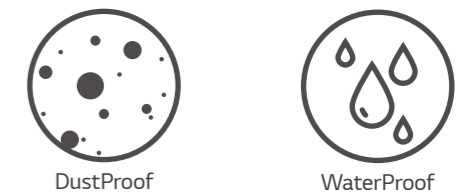

Anti-reflection & Optical Bonding Glass

The LG surgical monitor with optically bonded glass significantly reduces internal reflection between the cover glass and the LCD to enhance accuracy. Improved anti-reflection ability enables displays to look brighter and sharper for the highest image quality. Now you can judge accurately with high legibility and definition during the operation without eyestrain.



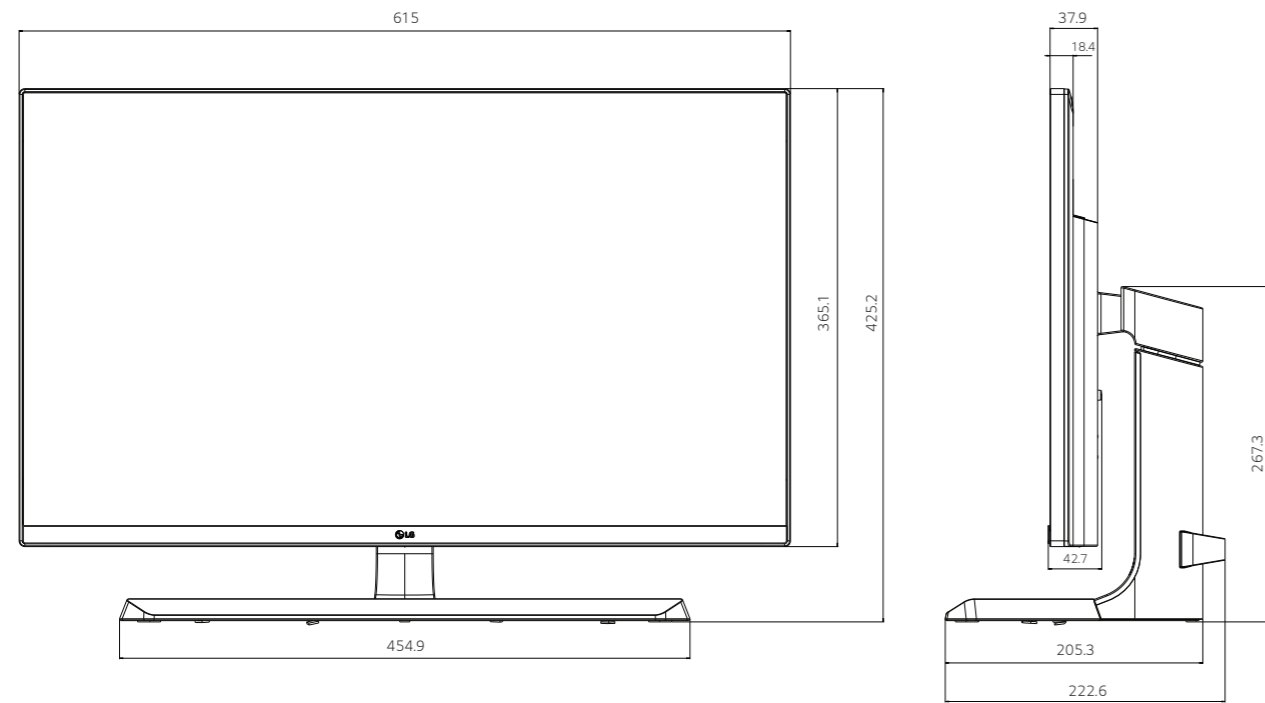

8MP Clinical Review Monitor

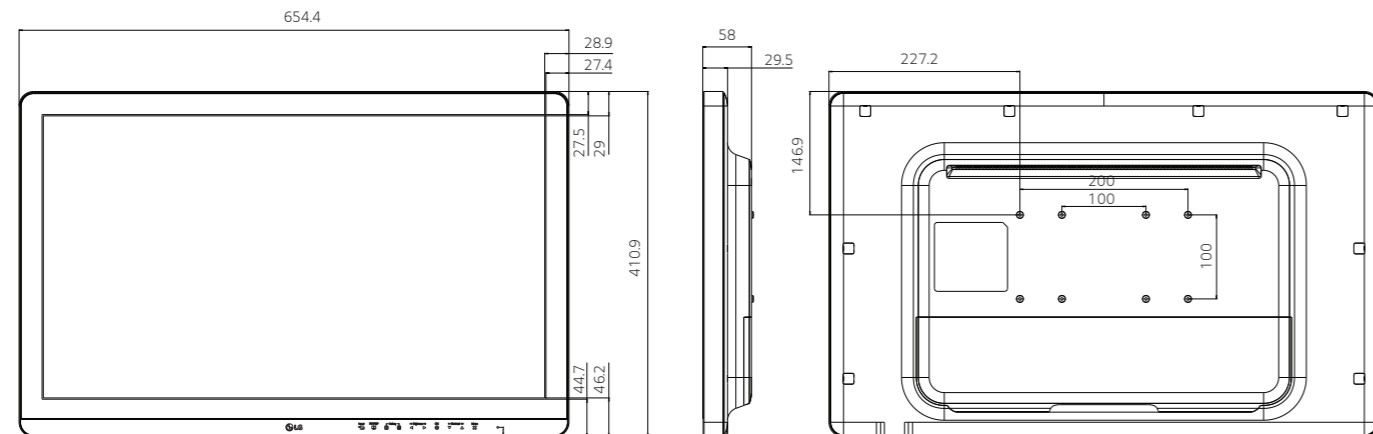

8MP Surgical Monitor



Specifications

		LG 8MP Clinical Review Monitor 27HJ712C	LG 8MP Surgical Monitor 27HJ710S
ITEMS			
Panel	Type	IPS	IPS + Glass
	Size	27" (16:9)	27" (16:9)
	Native Resolution	3840 x 2160	3840 x 2160
	Pixel Pitch	0.1554mm x 0.1554mm	0.1554mm x 0.1554mm
	Display Colors	10bit/sRGB 99%	10bit/sRGB 99% + Deep Red
	Viewing Angles	178/178	178/178
	Brightness	350cd/m2	800cd/m2
	Surface Treatment	-	Optical Bonding Glass (1.3T)
	Contrast Ratio (typical)	1000:1	1000:1
Video Signals	Response Time (typical)	14ms (Typ.)	14ms (Typ.)
	Input Terminals	HDMI(2.0) x 2, DP(1.2) x 1	HDMI(2.0) x 1, DP(1.2) x 1, DVI-D x 1, 3G-SDI x 1
	Output Terminals	Headphone Out	DP(1.2) x 1, DVI-D x 1, 3G-SDI x 1
	Digital Scanning Frequency (H/V)	30~135kHz / 56~61Hz	HDMI, DP: 30~135kHz / 56~61Hz DVI-D: 30~83kHz / 56~61Hz
USB	Sync Formats	Dynamic Sync Mode (Thru Mode)	Dynamic Sync Mode (Thru Mode)
	Function	1upstream, 2downstreams	1upstream, 1downstream (For calibration)
Power	Standard	USB3.0	USB3.0
	Power Requirements	100-240Vac, 50/60Hz	100-240Vac, 50/60Hz
	Maximum Power Consumption	65W	120W
	Power Save Mode	0.5W	-
Power Management	0.3W	0.3W	
Sensor		Brightness Stabilization	Brightness Stabilization
Environmental Requirements		-	IP35 / IP32 (Front / Back)
Certifications & Standards		IEC(IEC60601-1 / IEC60601-1-2), FCC(FCC part 15 Class A), CB, UL(UL60601-1), C-UL-US, KC, RoHS, REACH, WEEE, CISPR, EN, ANSI, AAMI, CE MDD(Class 1)	IEC(IEC60601-1 / IEC60601-1-2), FCC(FCC part 15 Class A), CB, UL(UL60601-1), C-UL-US, KC, RoHS, REACH, WEEE, CISPR, EN, ANSI, AAMI, CE MDD(Class 1)
Supplied Accessories		Power cord, HDMI Cable, DP Cable, USB Cable, Adapter, CD/Book Manual	Power cord, HDMI Cable, DP Cable, Adapter, CD/Book Manual
Physical Specifications	Weight(Without Stand)	4.7kg	7.7kg
	Weight(With Stand)	6.2kg	-

*The monitor stand is not included with the surgical monitor.